

Article number: 439600085

Description: Rota-fix shaft-hub connection FS85x125

Note: Self centering - very high torque.

Measures

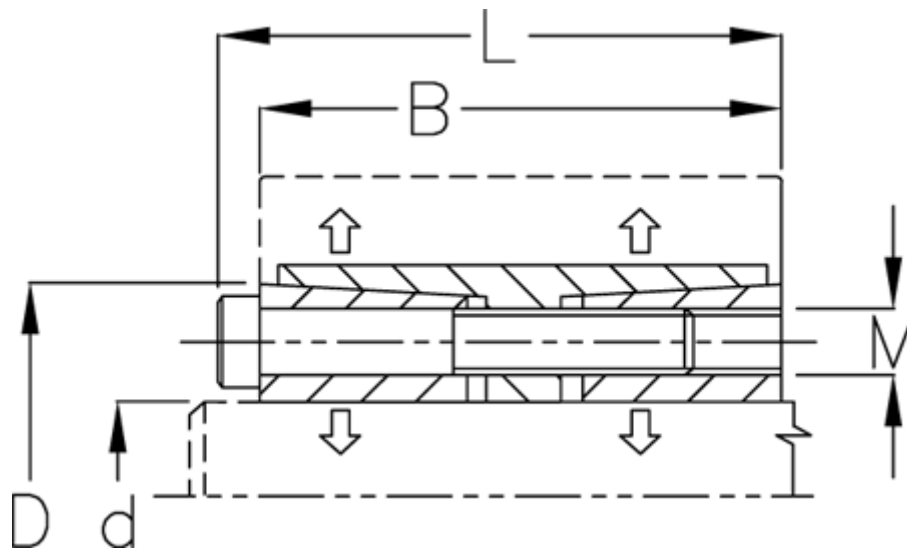

B mm	= 62
d H8 mm	= 85
D mm	= 125
Fit tolerance	= Aksel h8, Nav H8
F kN torque	= 259.0
L mm	= 72
M mm	= M10
P N/mm ² surface pressure on shaft/hub	= 138

Surface roughness	= R? ? 3.2 μm
T N m torque	= 11000
Ts N m bolt tightening torque	= 83.0